

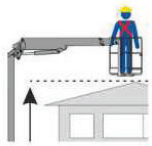

30,20 m

-7,00 m



16,00 m



225 kg



260 KG



90°+90°



28,20 m



360°



ELECTRONIC + RADIO

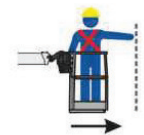

15,50 m



ALUMINIUM
1,8X0,7X1,1

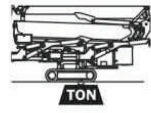

5,0 T

DT30 SPYDER

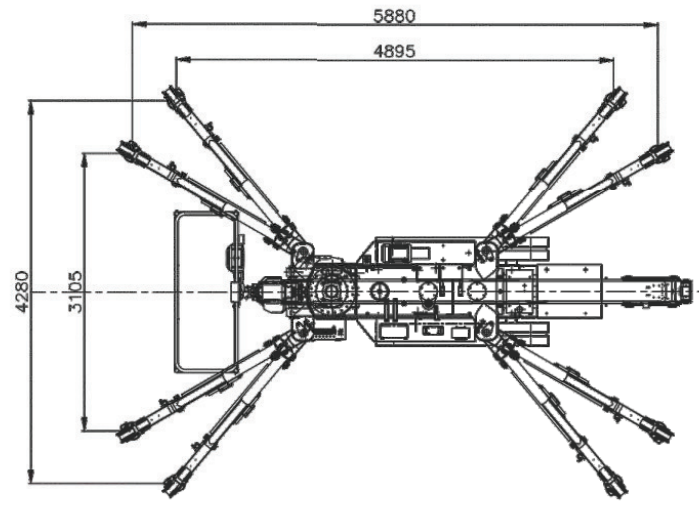
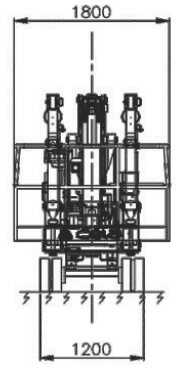
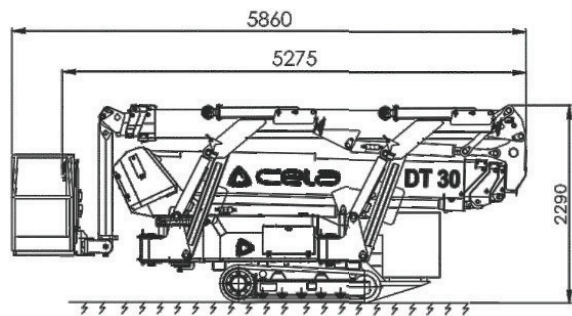
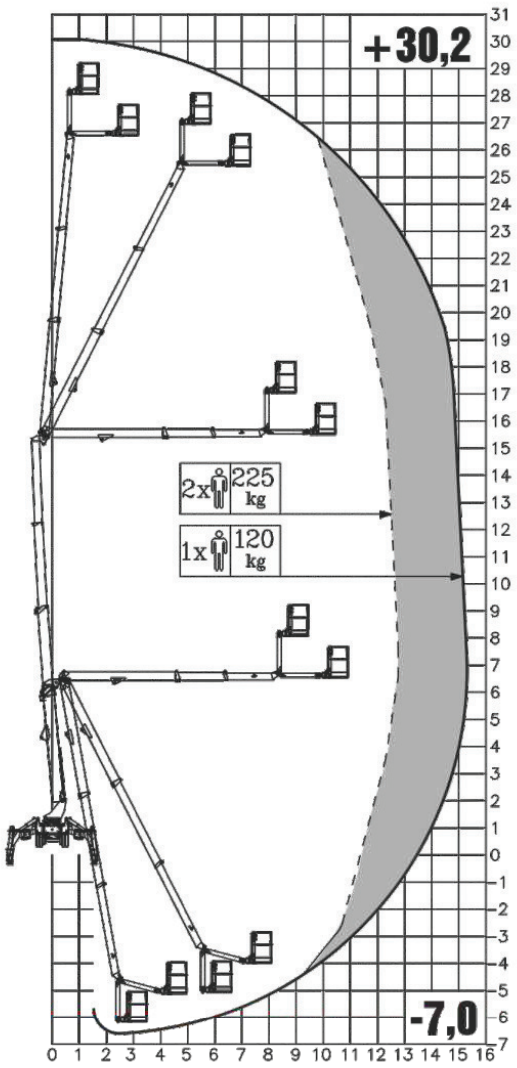

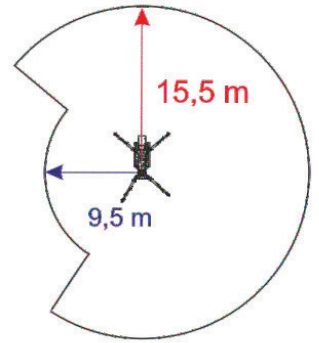
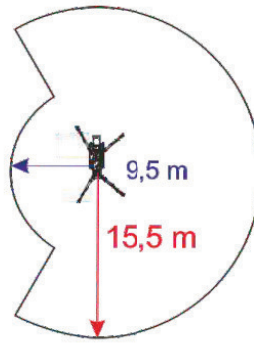
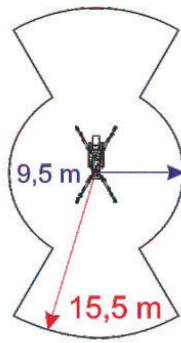
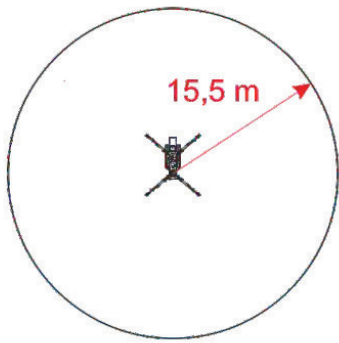

Passiamo sopra ogni cosa
We fly all over



**16 mts up and
15,5 mts over:
never so high**

Sottosopra
Downunder

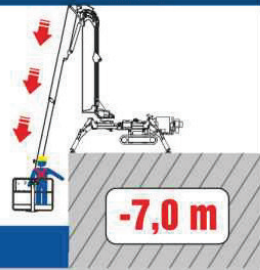

Tutto in uno
All in one



Atterriamo ovunque
We land everywhere

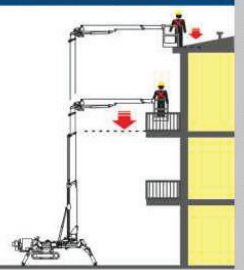

Come un ascensore
Like an elevator

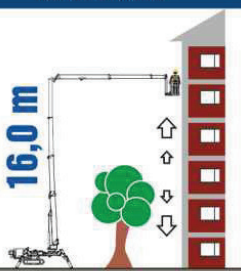

Dolci e Veloci
Smooth and fast

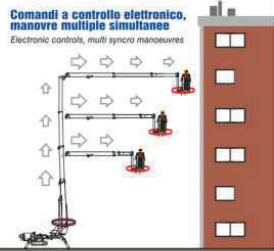

Auto Stabilizzazione
Automatic Stabilization

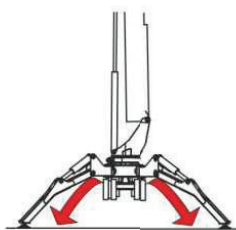

Siamo i più forti
We are the strongest

225 kg



260 kg



Doppia Omologazione
Crane/Platform
CE Certificate

Non ti facciamo girare la testa
We don't drive (your head) crazy

90° + 90°

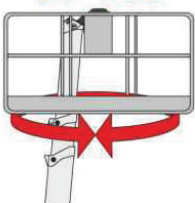

Sempre al tuo fianco
Always with you

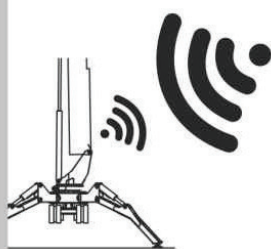

Autocaricamento
No ramps needed

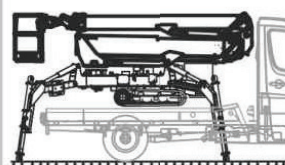

Bini Gru di Bini Roberto
Sede Legale Via Aldo Moro, 12 - 40155 Casale d'Argile (BO) - Italy
Sede Operativa Via XX Settembre, 7/C - 40157 Casfano (BO) - Italy
P.Iva 00023411205 - C.F. BNRPT637045141 - REA 307372
Tel. +39 (0) 51 027216 - Mob. +39 348 7614707
www.binigru.it info@binigru.it



> **DT30**
SPYDER